

THULE[®]
SWEDEN

➤ Instructions

Thule Evo Raised Rail
710410

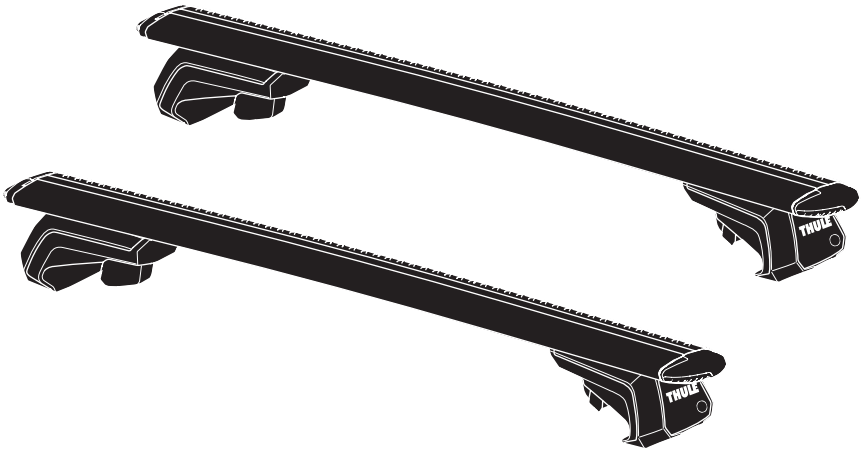

5560445001

Bring your life
thule.com

EN Roof mounted load carrier
DE Lastenträger zur Dachmontage
FR Barre de toit
NL Dakdrager
IT Barra portatutto da installare sul tetto
ES Portaequipajes de techo
PT Barra para montagem no tejadilho
SV Takmonterad lasthållare
DK Tagmonteret lastholder
NO Takmontert lasteholder
FI Katolle asennettava teline
ET Katusele paigaldatav katuseraam
LV Uz jumta uzstādāms kravas turētājs
LT Ant stogo tvirtinamas krovinių laikiklis
PL Uchwyt na bagażnik bazowy montowany na dachu
RU Багажник на крышу
UK Багажник для даху
BG Багажник, монтиран върху покрива
CS Nosič pro montáž na střechu

SK Strešný nosič
SL Nosilec za strešni prtljajnik
HR/BIH Krovni nosač tereta
RO Suport încărcătură montat pe acoperiș
HU Tetőre szerelhető csomagzállító
EL Σχάρα οροφής για μεταφορά φορτίου
TR Araç üstüne bağlanan yük taşıyıcı

HE מנשא מטען לגג הרכב
AR حامل نغل مثبت على السقف

ZH 顶置行李架
JA ルーフマウント型ロードキャリア
KO 루프 장착 화물 캐리어
TH โครงยึดของบรรทุกแบบติดตั้งบนหลังคา

CITY CRASH

Complies with ISO norm

ISO 11154-E

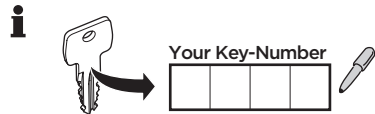
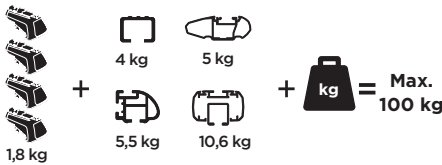
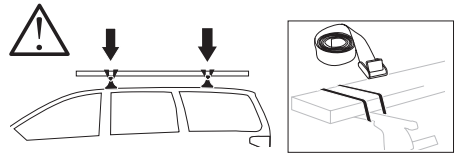
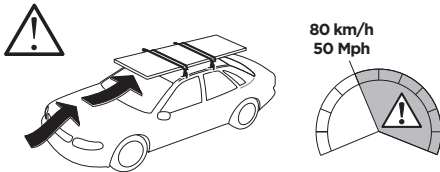
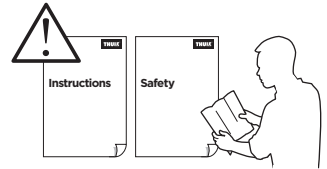

›Mounting Tutorial

Thule Evo Raised Rail

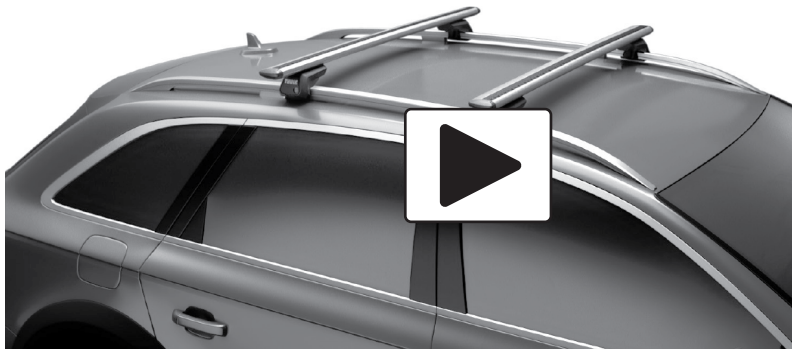

thule.com

2
FOOT PACK

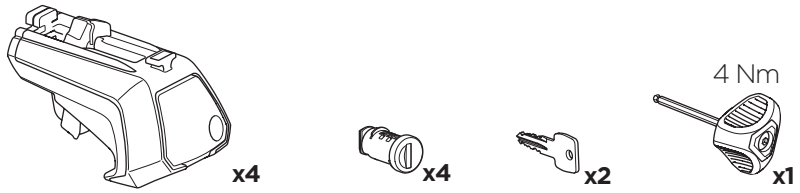

3
BAR

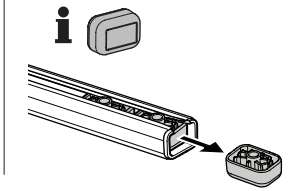
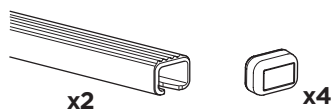
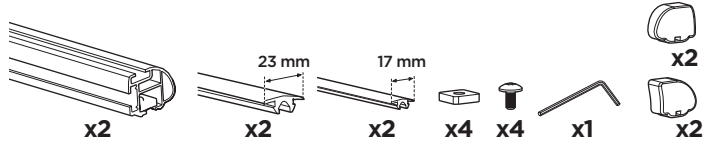
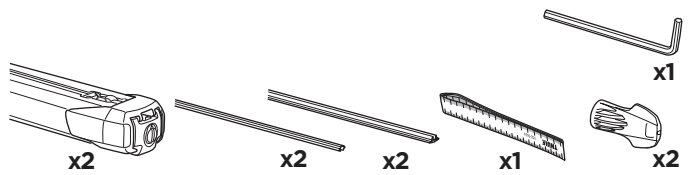
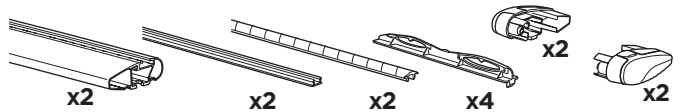
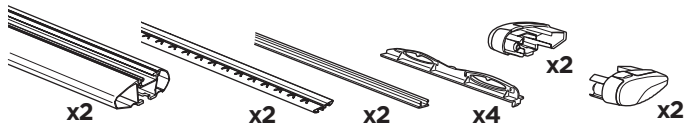

1

BAR

3

THULE
WingBar Evo



A

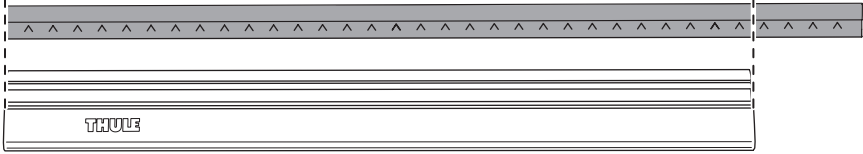

B

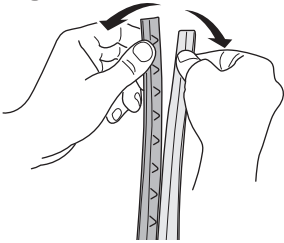

C

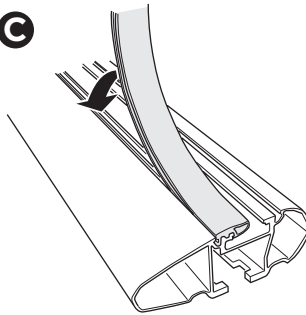

D

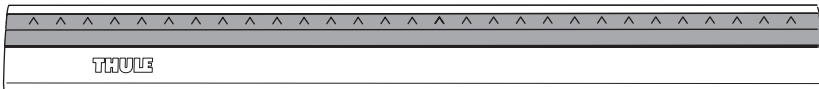
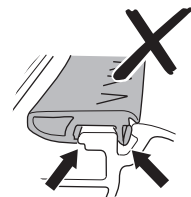
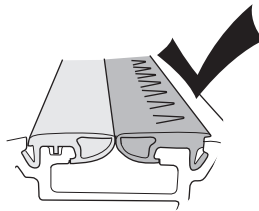
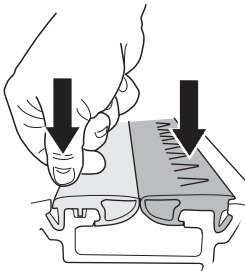
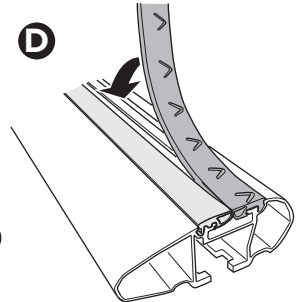

x2

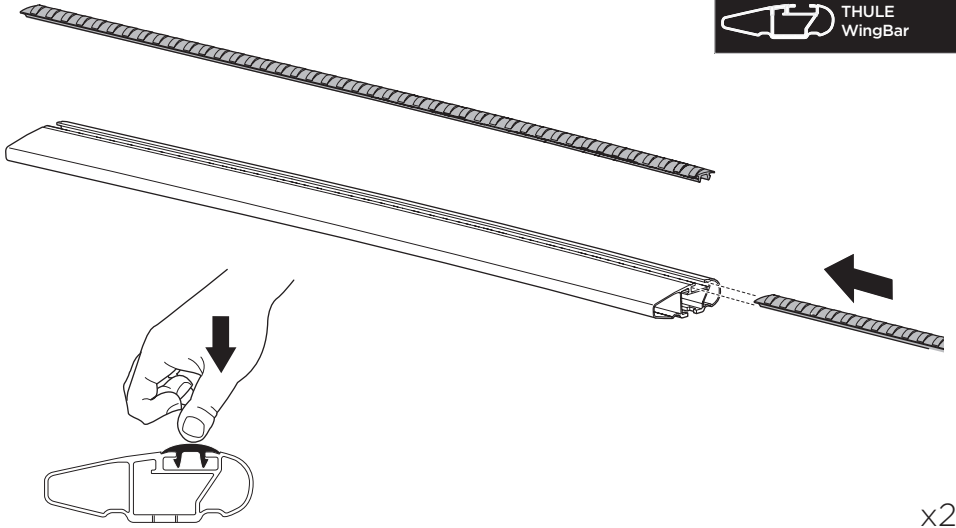

2



A



B



C

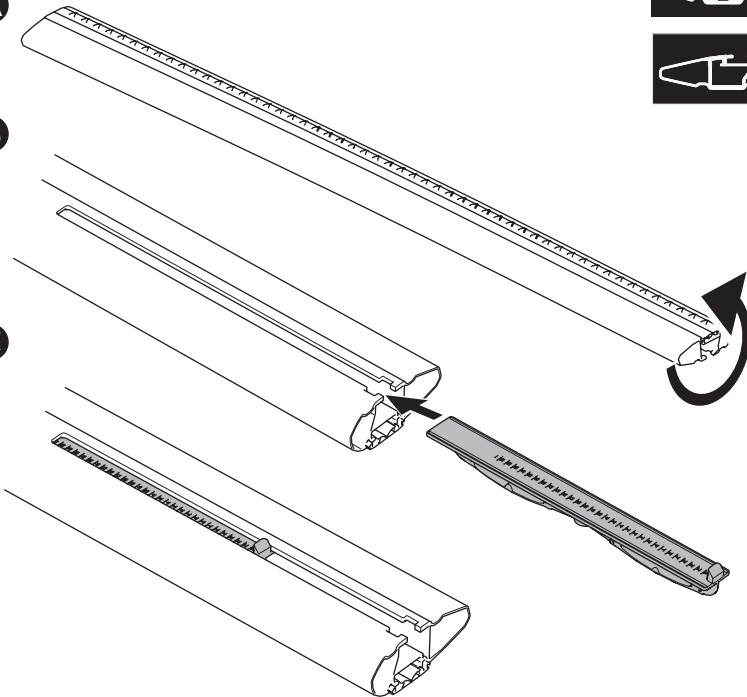

3

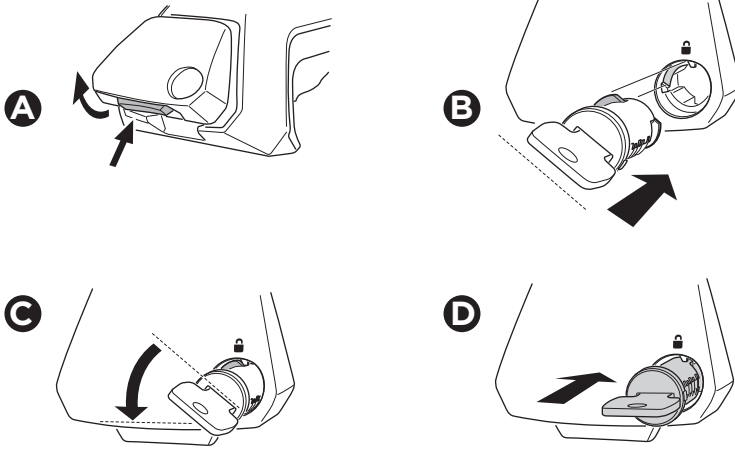

x4

4

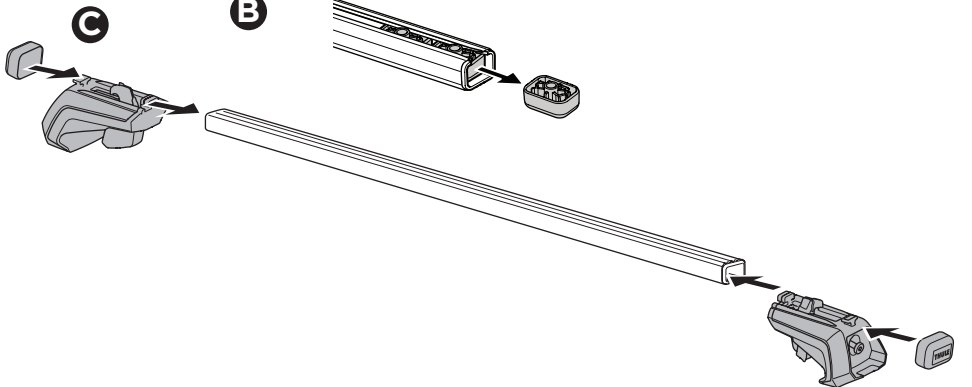
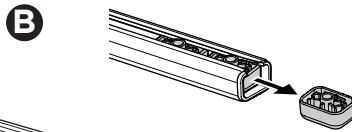
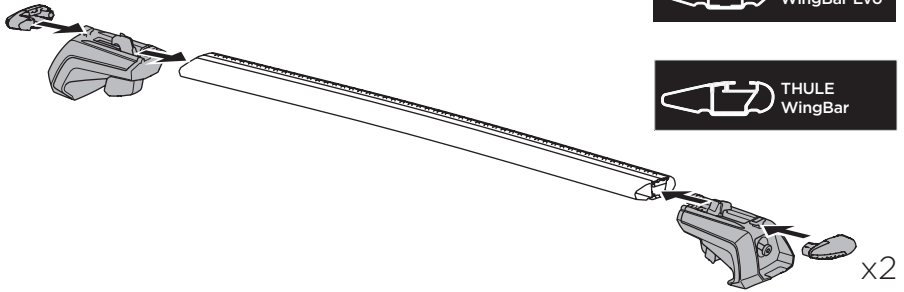

x2

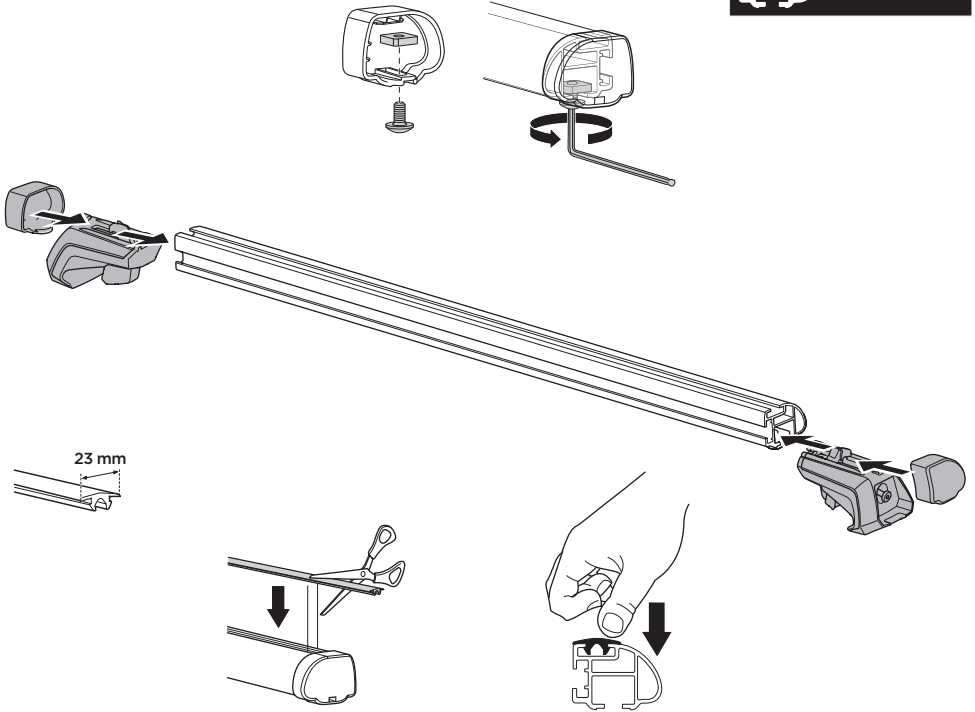

x2



5

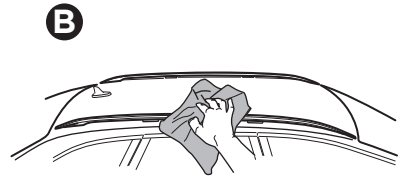
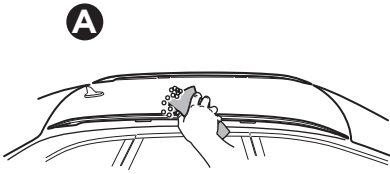

6

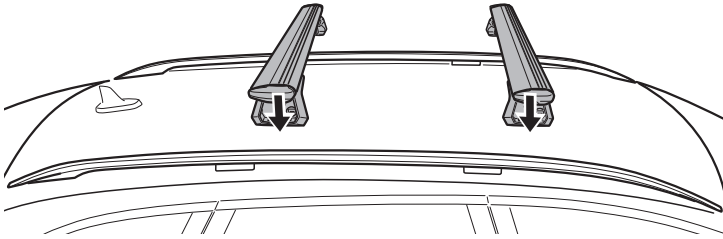
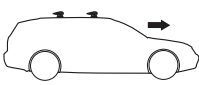

7

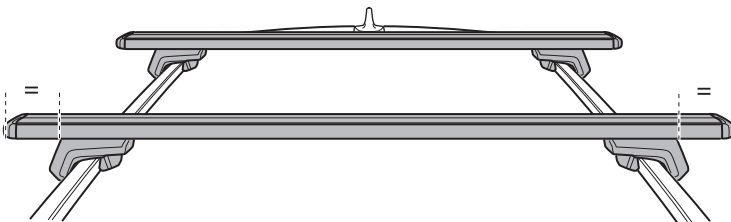
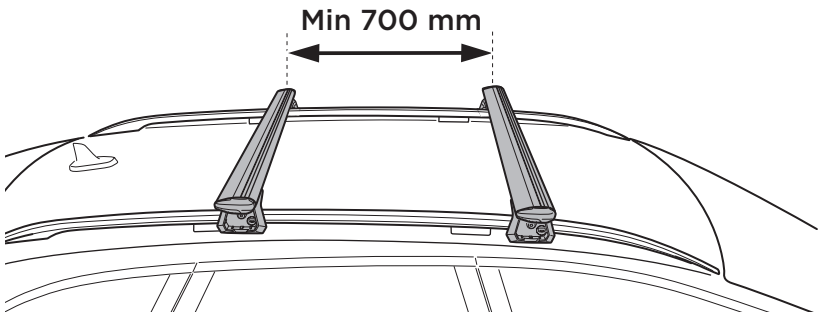

8

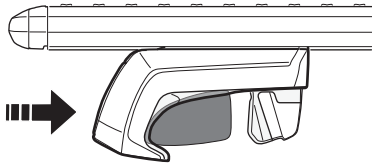
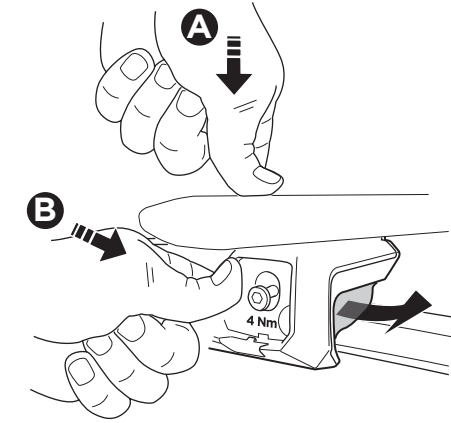

x4

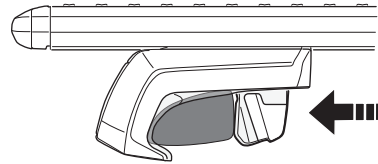
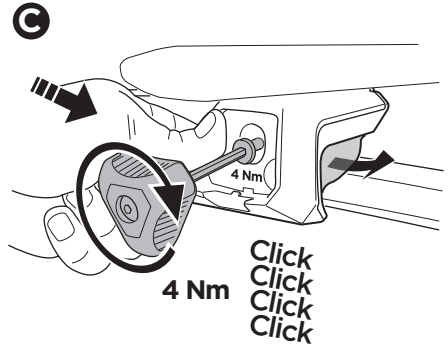

x4

ok ✓

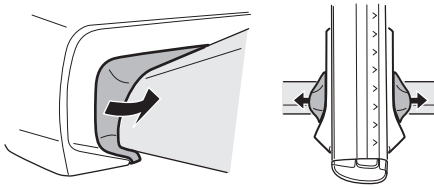

Not ok ✗

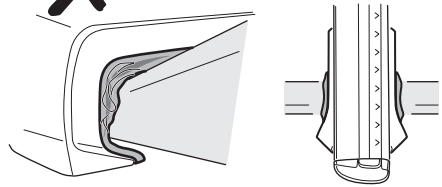

STOP



50 km



500 km

STOP

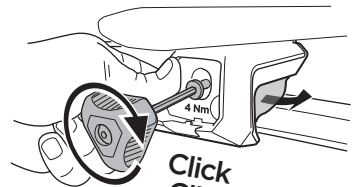

9

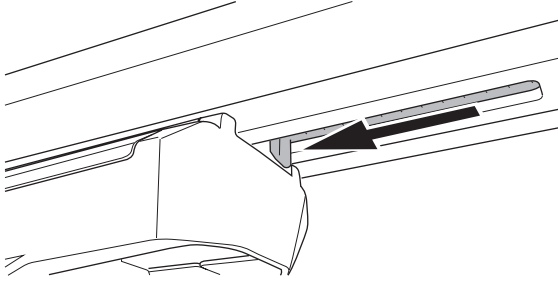

x4

10

A

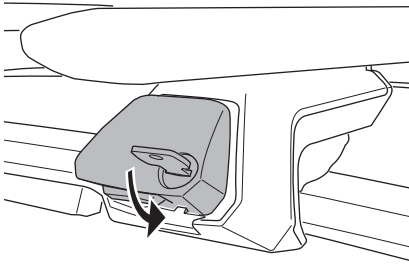

B

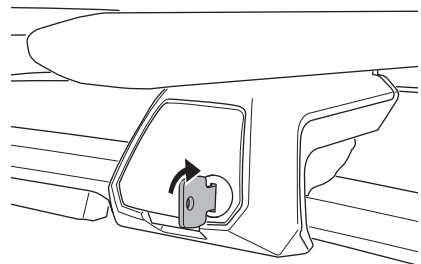

x4

11

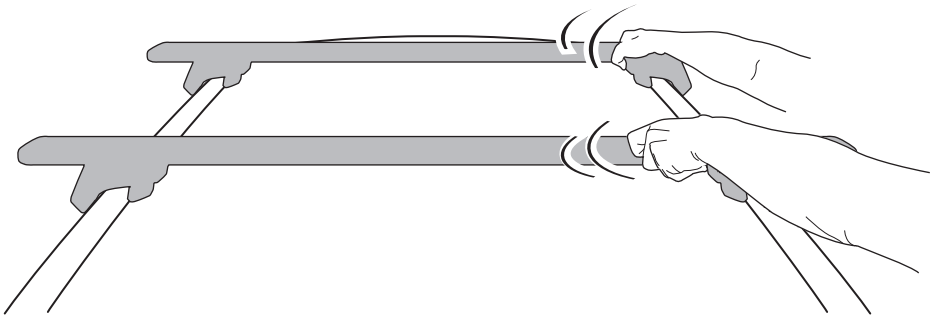

12

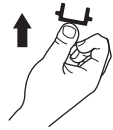
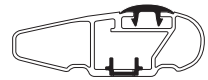
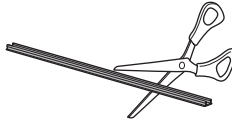

x4

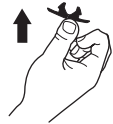
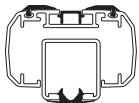
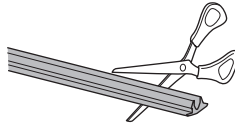
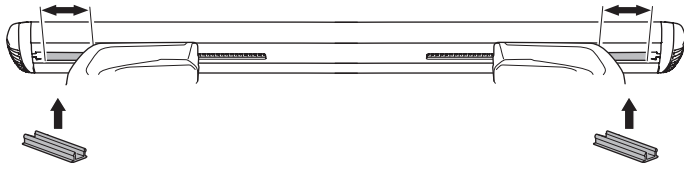

x2

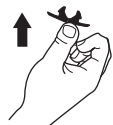
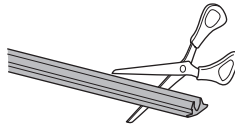
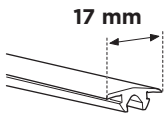
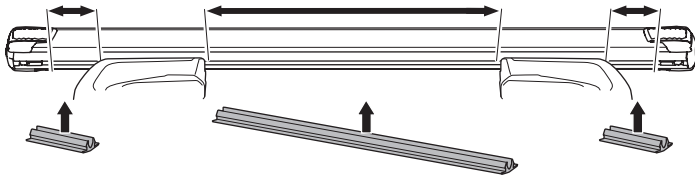

x2

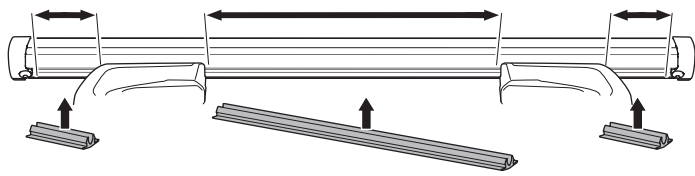

i

