

# ➤ Instructions

## Thule Load Stop 502000

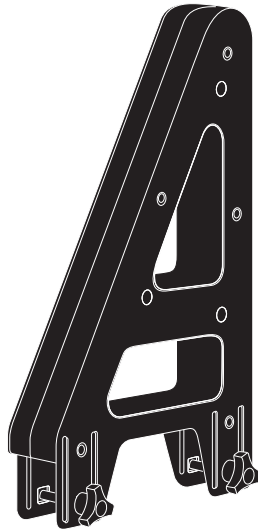

- EN** Load stop for roof-mounted racks  
**FR** Arrêteur pour barres de toit  
**ES** Tope de carga para racks de techo  
**DE** Ladungsbegrenzer für Dachträger  
**NL** Laadstop voor dakdragers  
**PT** Fixador de carga para barras de tejadilho  
**IT** Fermacarichi per portapacchi da installare sul tetto  
**SV** Laststopp för takmonterade räckor  
**DK** Laststop til tagbjælger  
**NO** Load Stop til takmonterte stativer  
**FI** Kuormanrajaaja katolle asennettaviin telineisiin  
**IS** Festiklemma fyrir grindur á þak  
**ET** Katusele paigaldatav koormapiiraja  
**LV** Kravas atduris uz jumta uzstādāmiem bagāžniekiem  
**LT** Krovinio ribotuvas, skirtas ant stogo tvirtinamiems skersiniams  
**RU** Ограничитель груза для крышного багажника  
**UK** Обмежувач навантаження для багажників для даху  
**PL** Ogranicznik ładunku na bagażnik montowany na dachu  
**CS** Zarážka pro střešní nosiče  
**HU** Rakományűtköző tetőcsomagtartóhoz  
**RO** Opritor încărcătură pentru cadru de bare montate pe acoperiș

- SK** Zarážka pre strešné nosiče  
**SL** Kotnik za strešne prtljažnike  
**BG** Ограничител за багажник за релси, монтирани върху покрива  
**HR** Graničnik tereta za krovne nosače  
**EL** Στόπερ φορτίου για μπάρρες οροφής  
**TR** Araç üstüne bağlanan raflar için yük stoperi  
**MT** Load stop għal xtillieri mmuntati fuq saqaf  
**HE** מעצור טעינה לגג הרכב  
**AR** مصد حمولة للحوامل المثبتة على السقف

- ZH (CN)** 车顶架装载柱  
**ZH (TW)** 車頂架專用阻滑架  
**JA** ルーフマウント型ラック用ロードストップ  
**KO** 루프 장착 랙용 로드 스톱  
**TH** ที่กั้นสิ่งของไหลสำหรับแร็คหลังคา  
**MS** Hentian pemuatan untuk rak yang dipasang pada bumbung

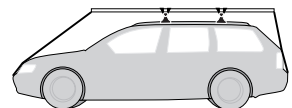
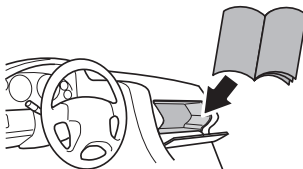
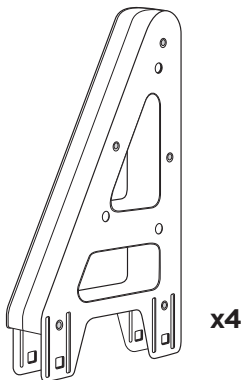
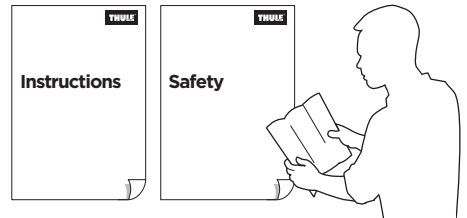

1

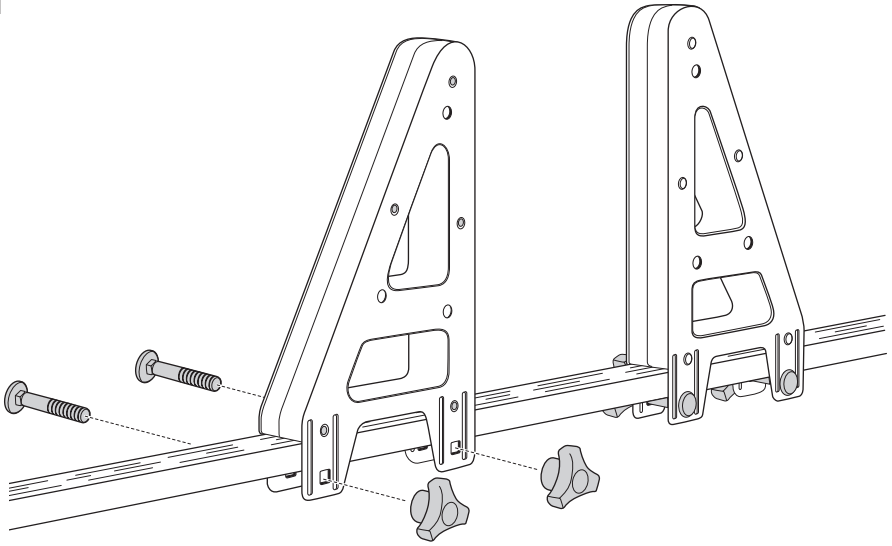

i

ok ✓

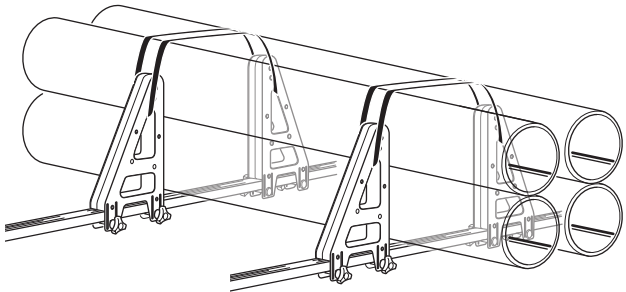

Not ok ✗

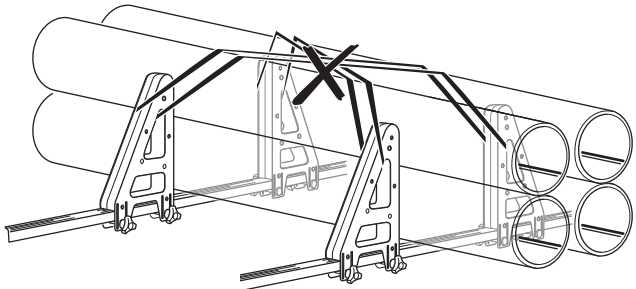

 Thule Sweden AB, Borggatan 5  
335 73 Hillerstorp, SWEDEN

» PART OF THULE GROUP

 [info@thule.com](mailto:info@thule.com)

© Thule Group 2021. All rights reserved.

 [www.thule.com](http://www.thule.com)

501-6220-06