

➤ Instructions

Thule Force XT

6351 6352 6355 6356 6357 6358

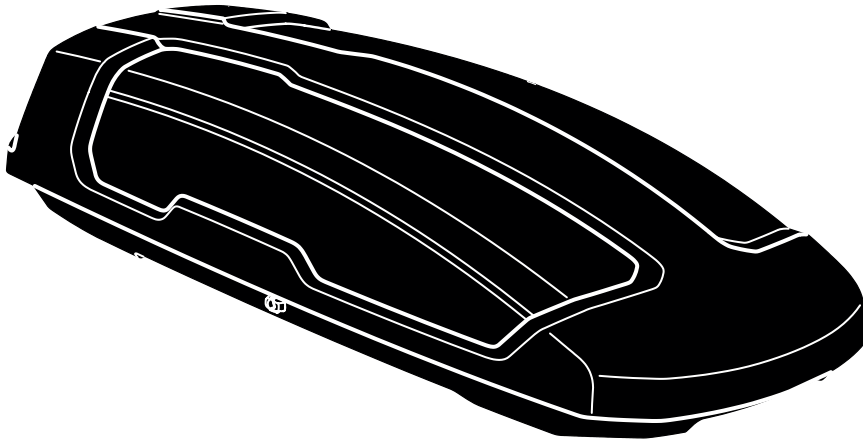

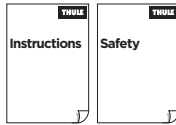

CITY CRASH
Complies with ISO norm

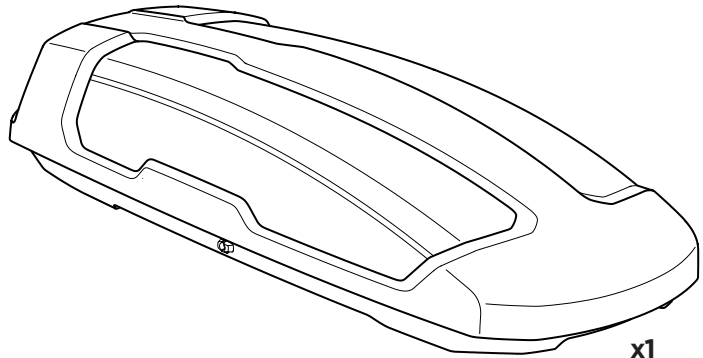

x1

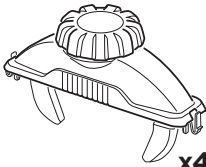

x4



x1

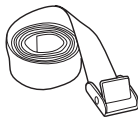

x3



x2



Your Key-Number

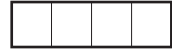

EN Roof box for roof-mounted racks
DE Dachbox für Dachträger
FR Coffre pour barres de toit
NL Dakkoffer
IT Box da tetto per portapacchi da installare sul tetto
ES Cofre portaequipajes para barras de techo
PT Caixa bagageira para barras de tejadilho
SV Takbox för takmonterade räckan
DK Tagboks til tagbøjler
NO Takboks til takmonterte stativer
FI Katolle asennettaviini telineisiin sopiva kuljetuslaatikko
ET Katusele paigaldatav katuseboks
LV Jumta kaste uz jumta uzstādāmiem bagāžniekiem
LT Ant stogo tvirtinamų skersinių bagažinės
PL Box dachowy na bagażnik montowany na dachu
RU Грузовой бокс на крышу автомобиля

UK Вантажний бокс для багажників для даху
BG Кутия за багаж за релси, монтирани върху покрива
CS Střešní box pro montáž na střechu
SK Strešný box na strešné nosiče
SL Strešni kovček za strešne prtljažnike
HR/BIH Krovna kutija za krovne nosače
RO Portbagaj de acoperiș pentru cadru de bare montate pe acoperiș
HU Tetőre szerelhető tetőbox
EL Μπαγκάζιέρα οροφής για μπάρρες οροφής
TR Araç üstüne bağlanan raflar için tavan kutusu
HE תא חפצים ללג הרכב
AR صندوق سقف للحوامل المثبتة على السقف
ZH 用于车顶架的车顶箱
JA ルーフマウント型ラック用ルーフボックス
KO 루프 장착 랙 루프 박스
TH กล่องบนหลังคาสำหรับแร็คหลังคา

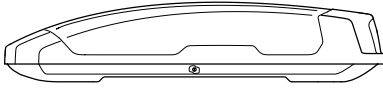

S	14,3 kg
M	16,4 kg
Alpine	19,4 kg
Sport	14,7 kg
L	18,7 kg
XL	21,3 kg

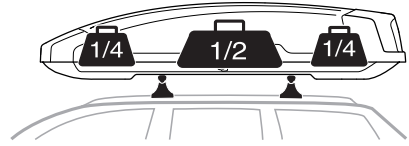

Max 75 kg



	D Min*	D Max*	W in*	W out*	H*	R Min*
S	557	845	786	896	388	971
M	557	932	710	820	424	1153
Alpine	557	909	590	700	394	1399
Sport	557	932	520	630	395	1227
L	557	918	730	840	428	1207
XL	557	911	750	860	410	1299

*mm

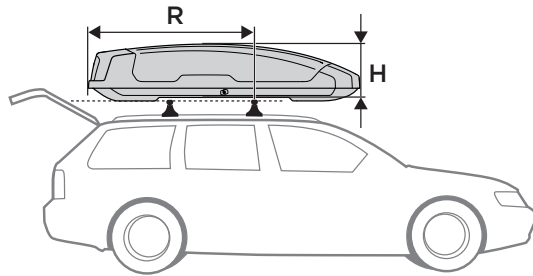
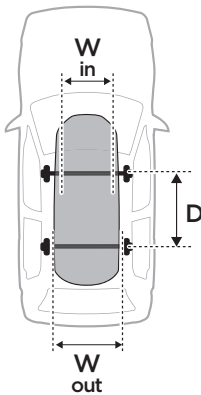

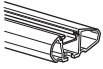

Thule WingBar Evo

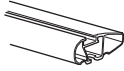

Thule WingBar



Thule AeroBar



Thule SlideBar



Thule Squarebar

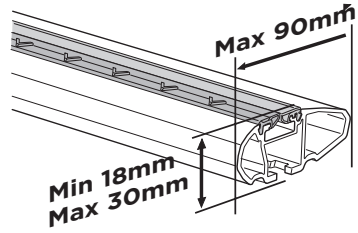
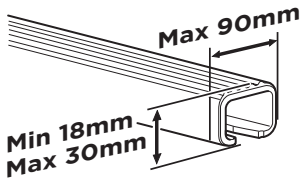

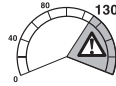
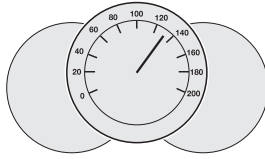

**Max
130 km/h**

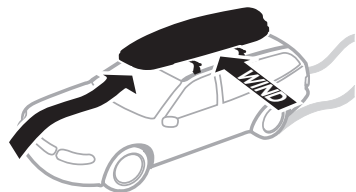
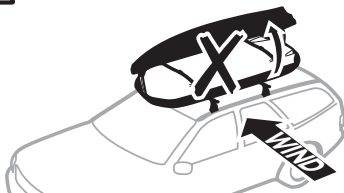
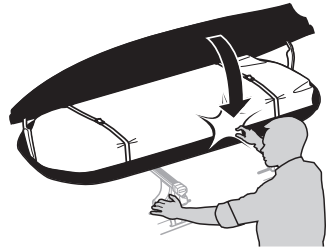
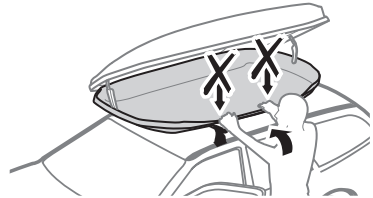
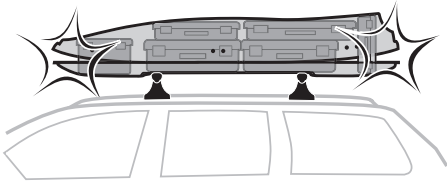

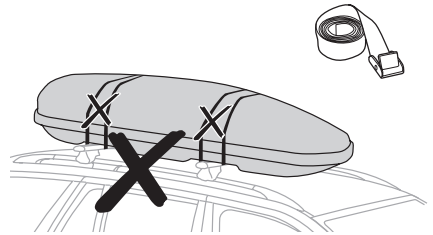
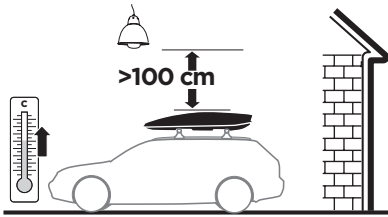
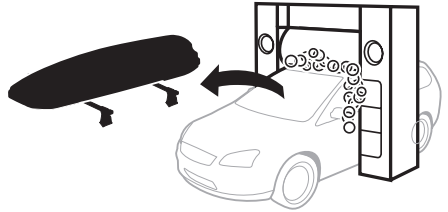
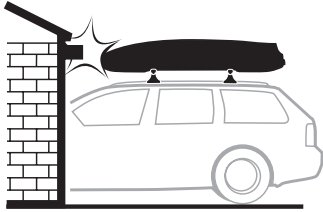
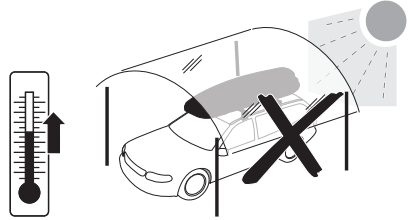
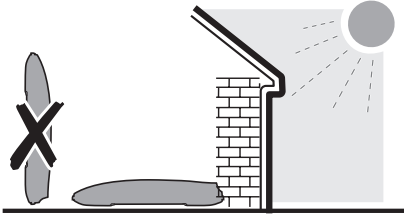

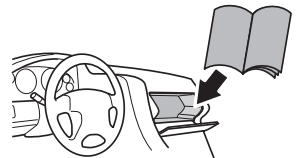
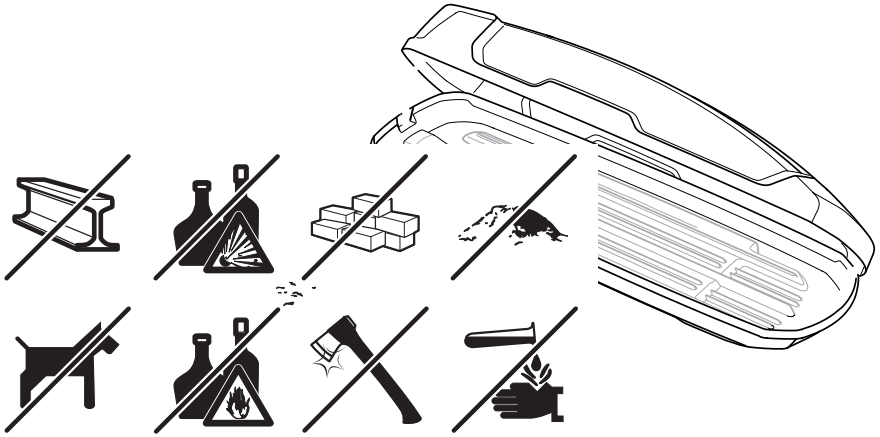

1

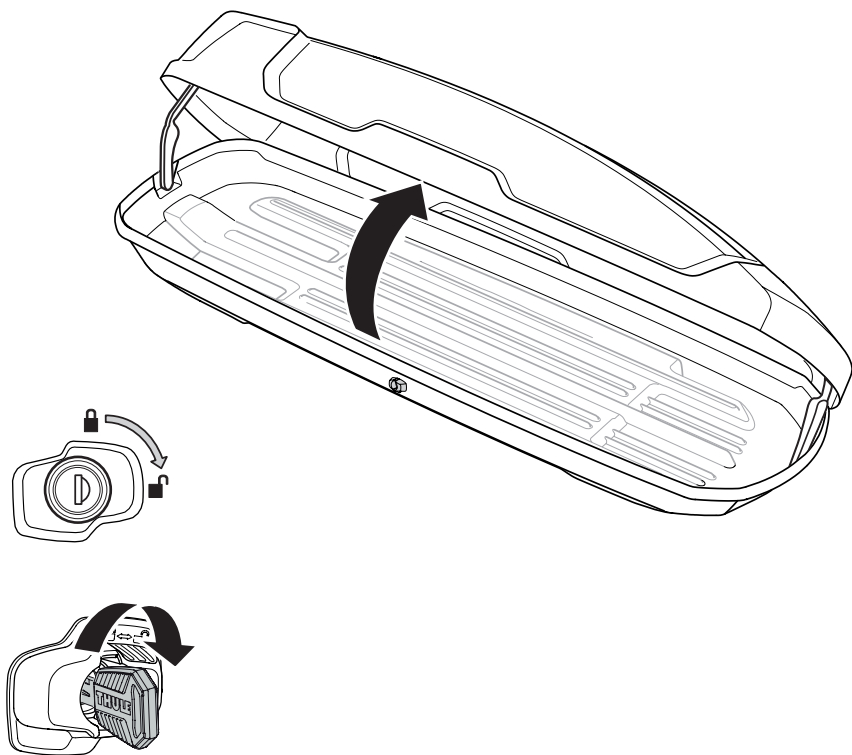

2

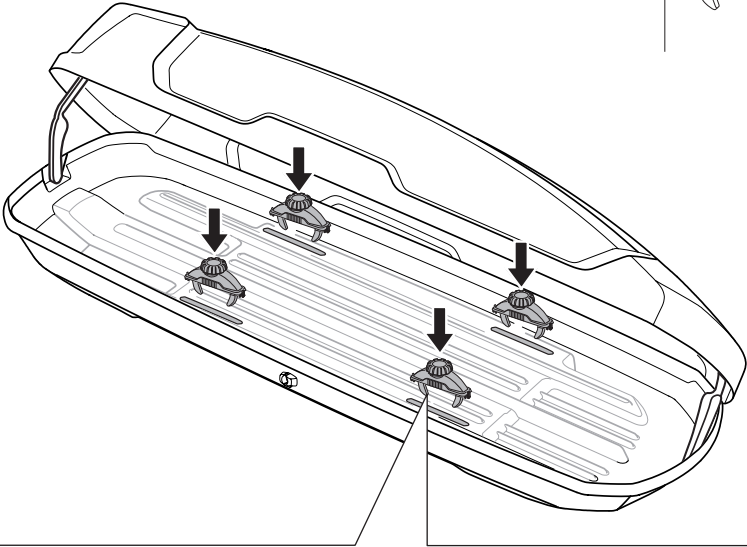

A

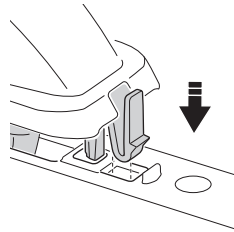
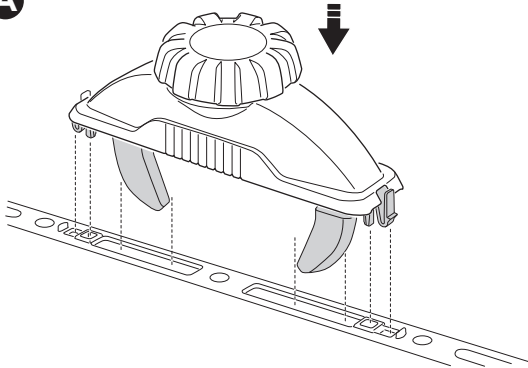

B

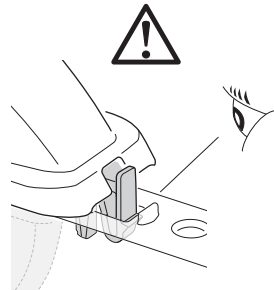
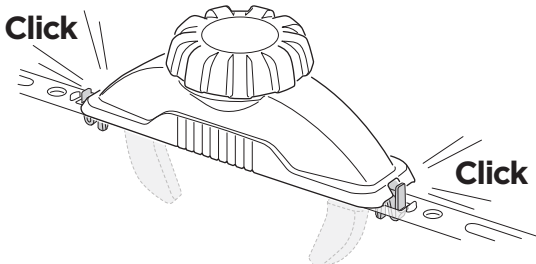

3

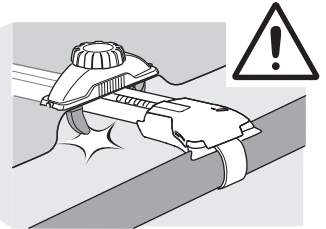
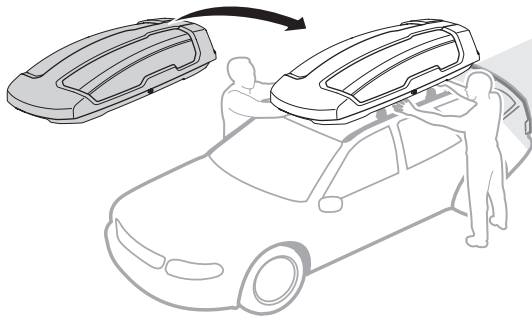
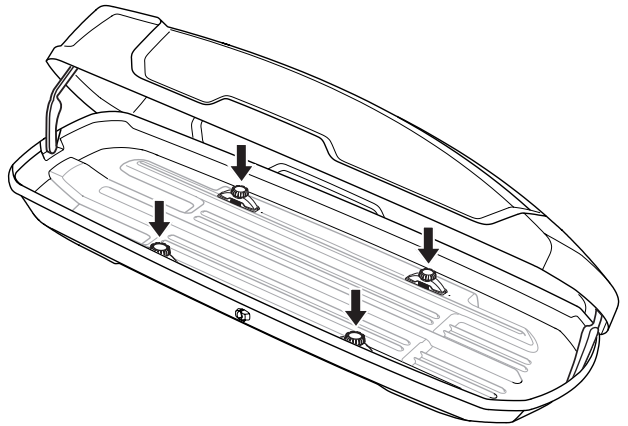
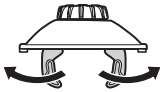

i

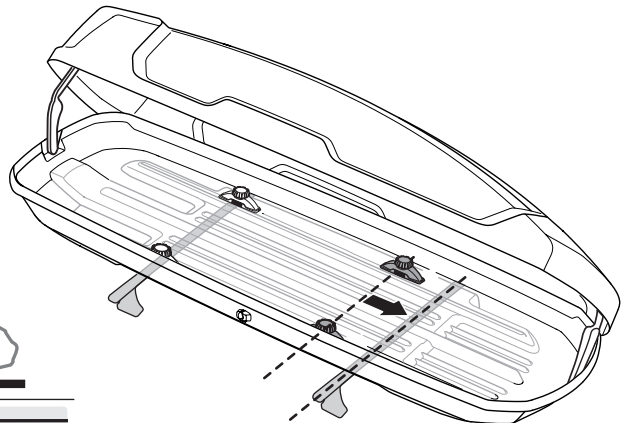
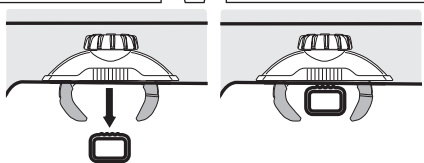
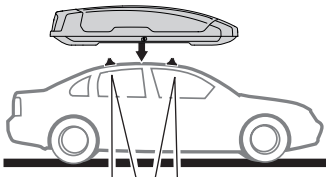

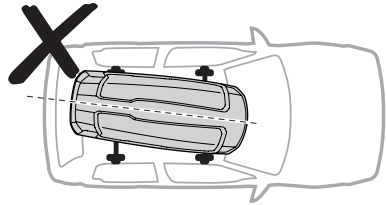
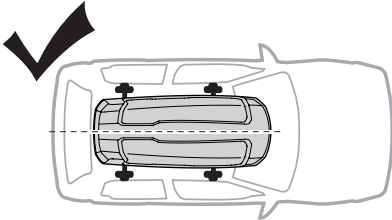
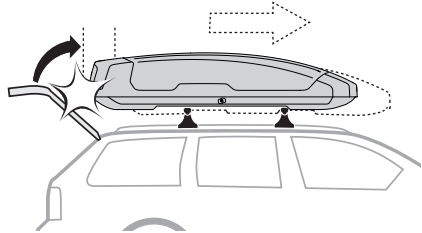
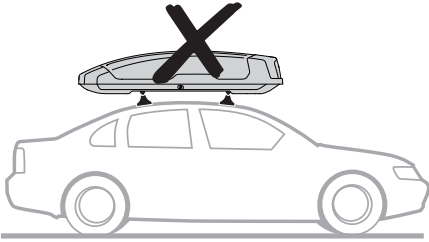

4

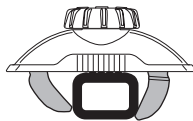
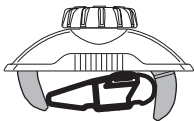
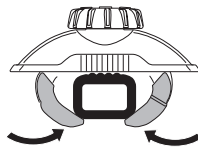
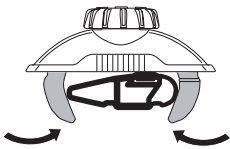
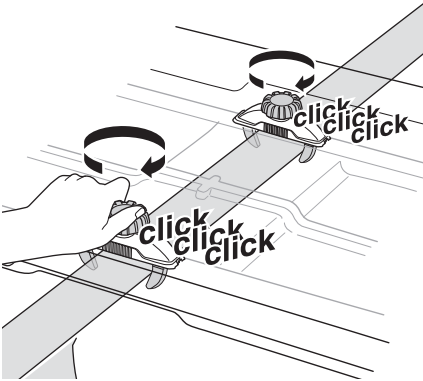
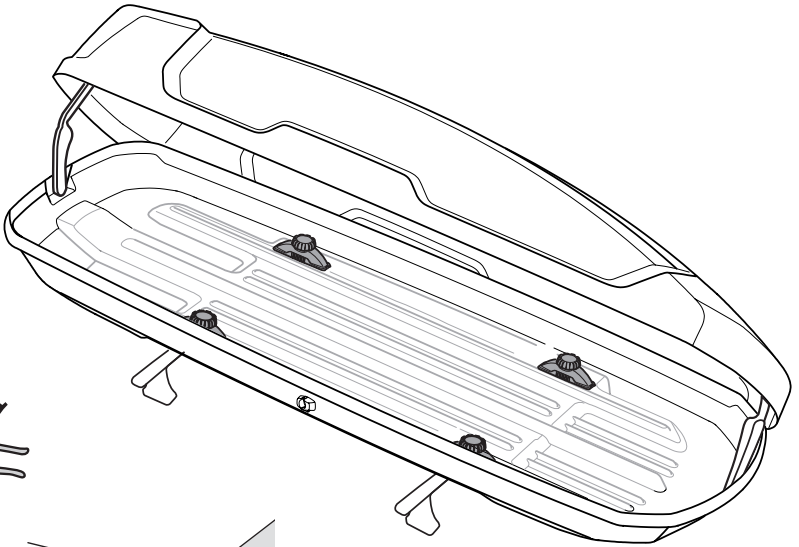

5

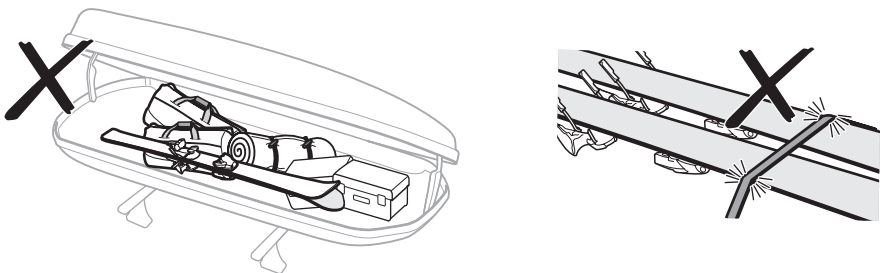
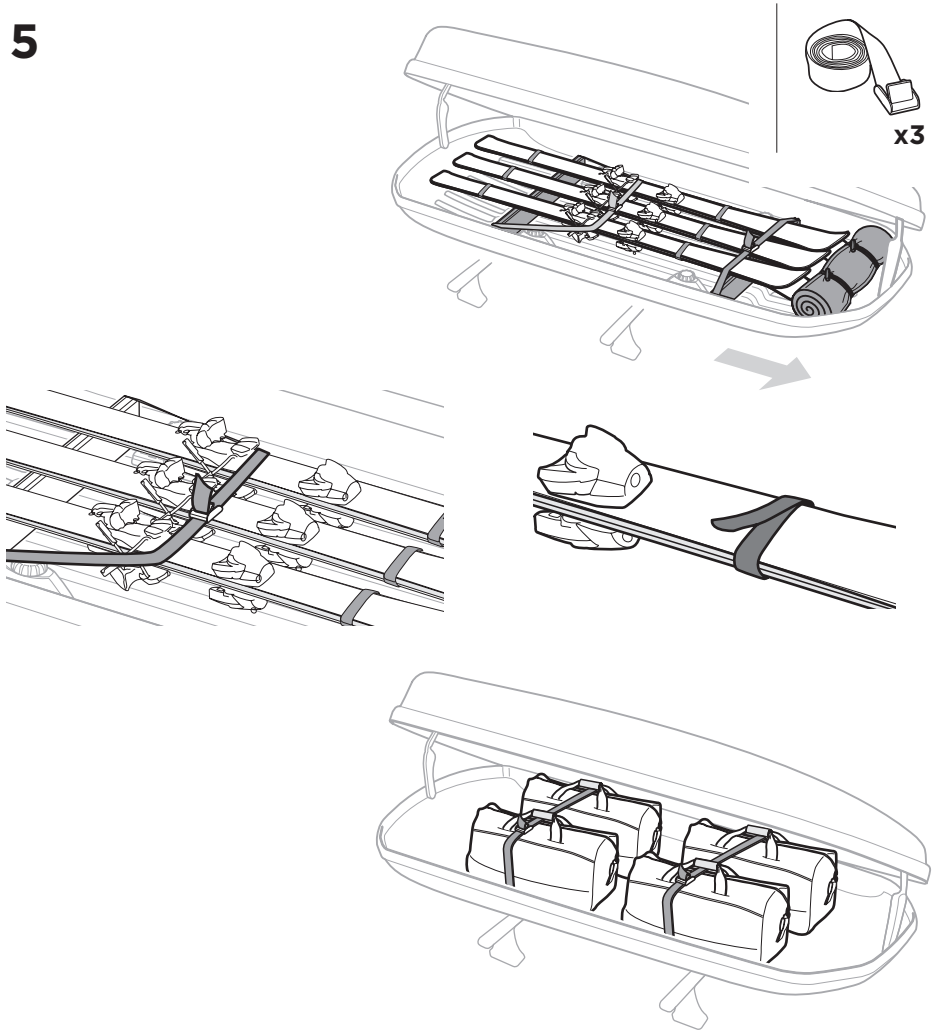

6

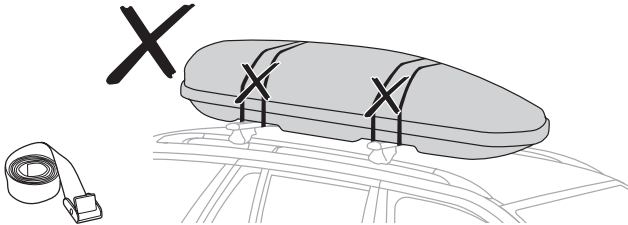
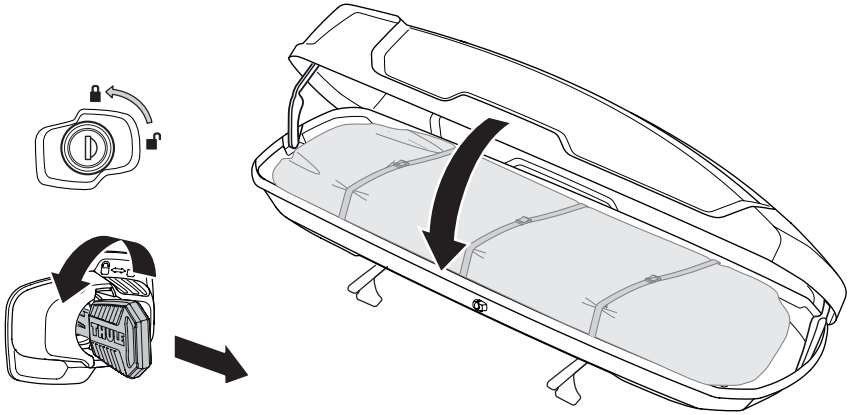

7

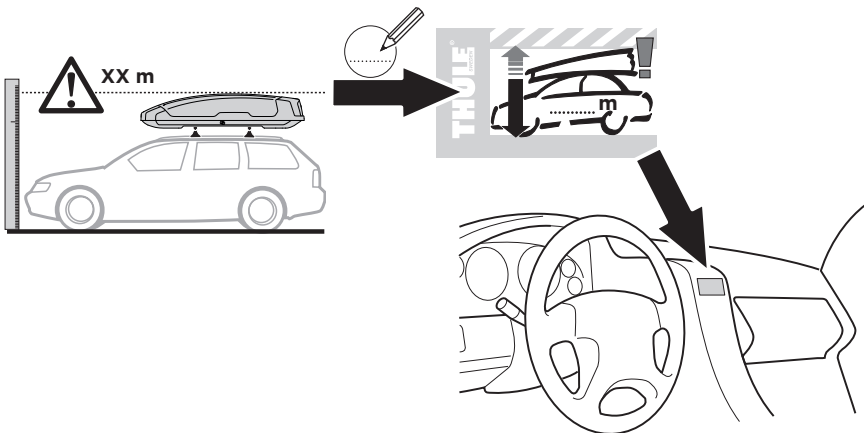

EN Accessories	DK Tilbehør	UK Аксессуары	EL Εξαρτήματα
DE Zubehör	NE Tilbehør	BG Принадлежности	TR Aksesuarlar
FR Accessoires	FI Lisävarusteet	CS Doplněk	AR الملحقات
NL Accessoires	ET Lisavarustus	SK Príslušenstvo	HE תוספות
IT Accessori	LV Piederumi	SL Dodatki	ZH 附件
ES Accesorios	LT Priedai	HR/BIH Dodaci	JA アクセサリー
PT Acessórios	PL Akcesoria	RO Accesorii	KO 액세서리
SV Tillbehör	RU Аксессуары	HU Tartozékok	TH อุปกรณ์เสริม

Thule T-track Adapter

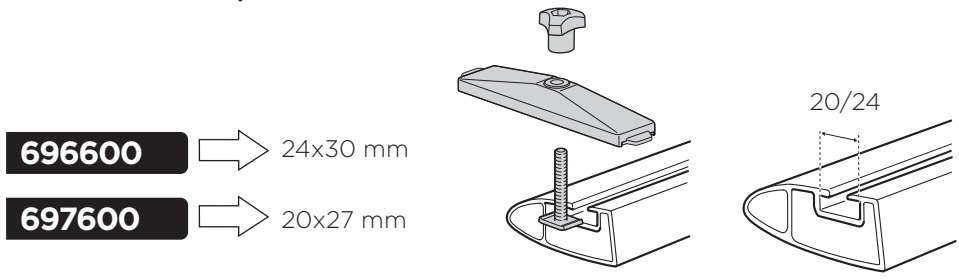

Thule MultiLift

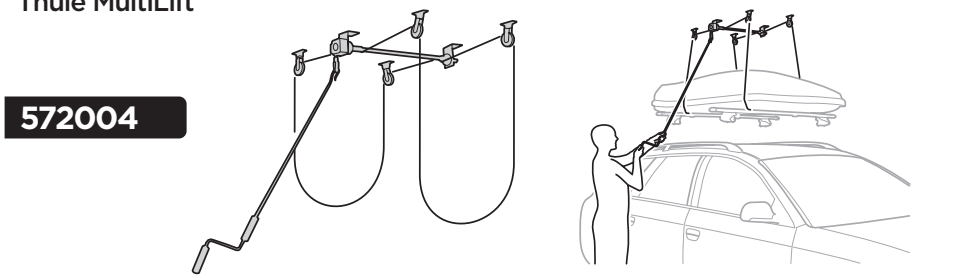

Thule Box Ski Carrier Adapter

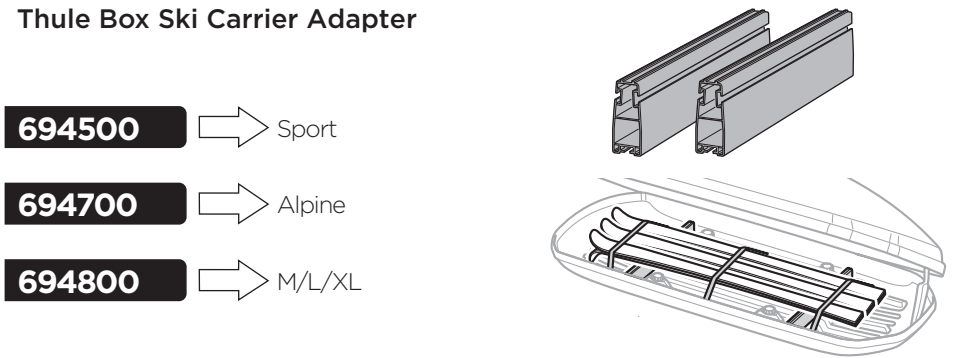

Thule Box Lid Cover

698100 → S/M/L

698200 → Sport/Alpine

698400 → XL

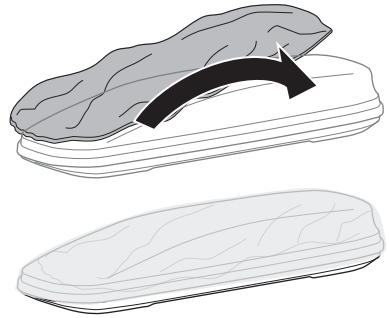

Thule One-Key System

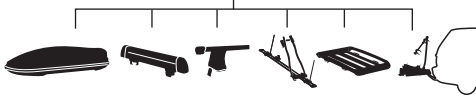

450400  (x4)

450600  (x6)

450800  (x8)

451200  (x12)

451600  (x16)

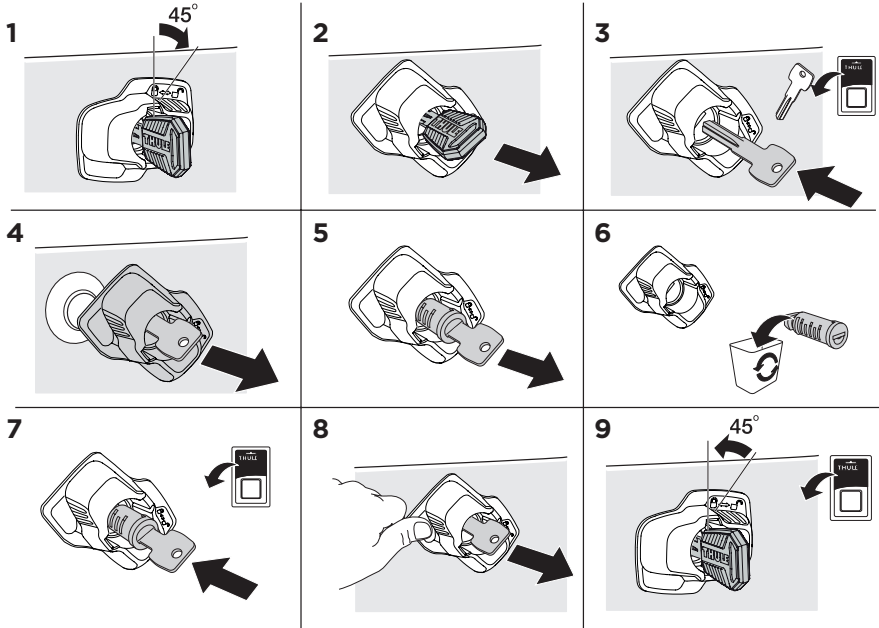

Thule Sweden AB
 Borggatan 5
 335 73 Hillerstorp, Sweden
 info@thule.com
 www.thule.com