

# 1

## Kit 145224

CHEVROLET Onix, 5-dr Hatchback, 19-



ISO 11154-E

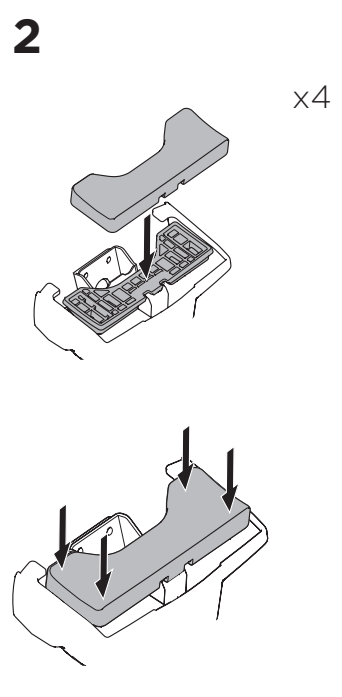
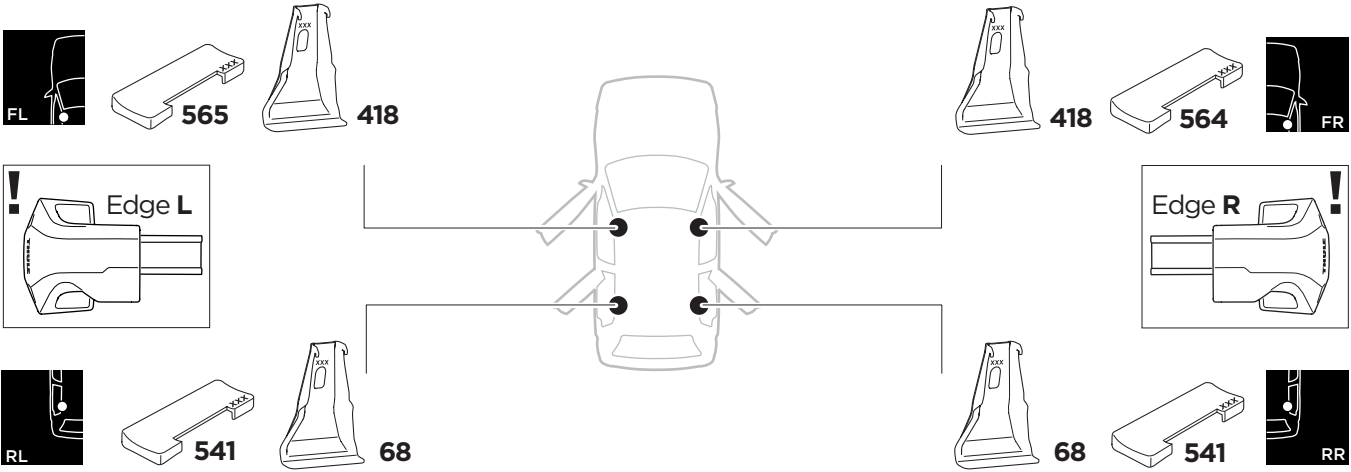
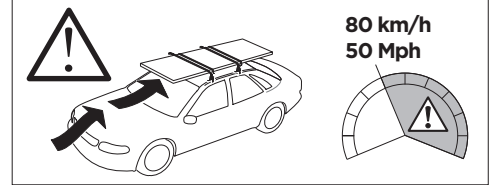
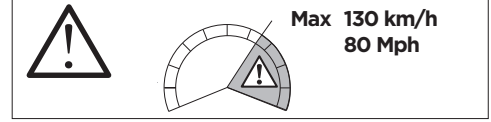
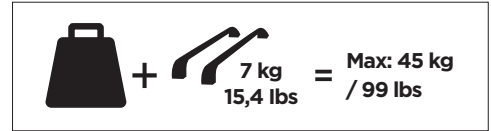
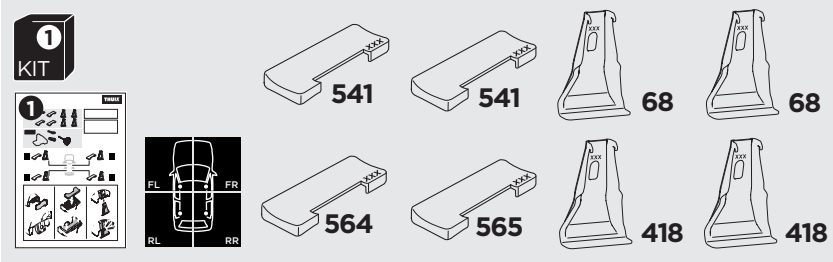



THULE WingBar Evo	THULE WingBar Edge	THULE WingBar	THULE SquareBar Evo	<b>Evo X (scale)</b>	<b>Edge X (scale)</b>
<b>CHEVROLET Onix, 5-dr Hatchback, 19-</b>				<b>35,5</b>	<b>H</b>
THULE ProBar Evo	THULE SlideBar Evo				<b>X (mm/inch)</b>
<b>CHEVROLET Onix, 5-dr Hatchback, 19-</b>				<b>1006 mm / 39 5/8"</b>	

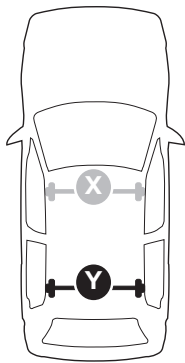

THULE WingBar Evo	THULE WingBar Edge	THULE WingBar	THULE SquareBar Evo	<b>Evo Y (scale)</b>	<b>Edge Y (scale)</b>
<b>CHEVROLET Onix, 5-dr Hatchback, 19-</b>				<b>32,5</b>	<b>N</b>
THULE ProBar Evo	THULE SlideBar Evo				<b>Y (mm/inch)</b>
<b>CHEVROLET Onix, 5-dr Hatchback, 19-</b>				<b>976 mm / 38 3/8"</b>	

	<b>W (mm/inch)</b>	<b>Z (mm/inch)</b>
<b>CHEVROLET Onix, 5-dr Hatchback, 19-</b>	<b>700 mm / 27 1/2"</b>	<b>250 mm / 9 7/8"</b>

