

1

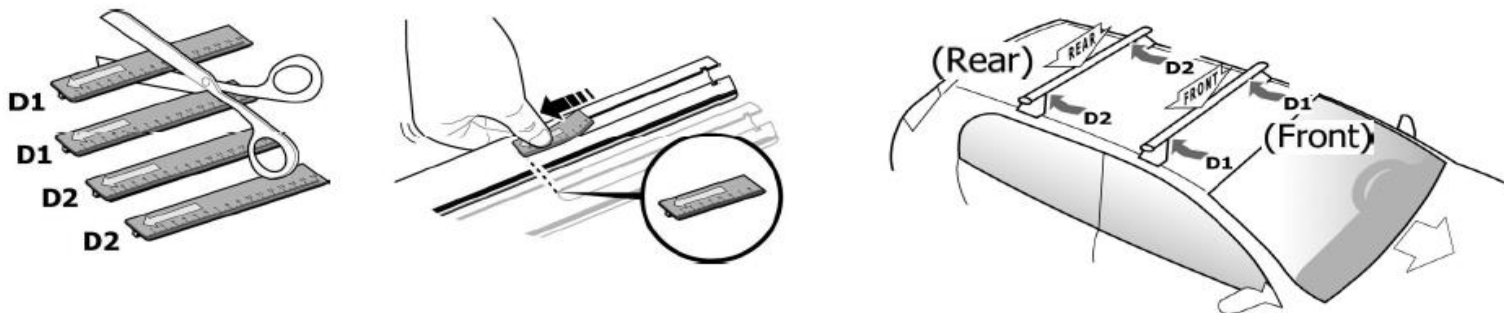

MANUFACTURER	MODEL CAR	DOORS	MODEL YEAR	D1	D2
FIAT	<i>Punto II</i>	3	99>07	10,6	14,1
FIAT	<i>Punto II Classic</i>	3	07>10	10,6	14,1

2

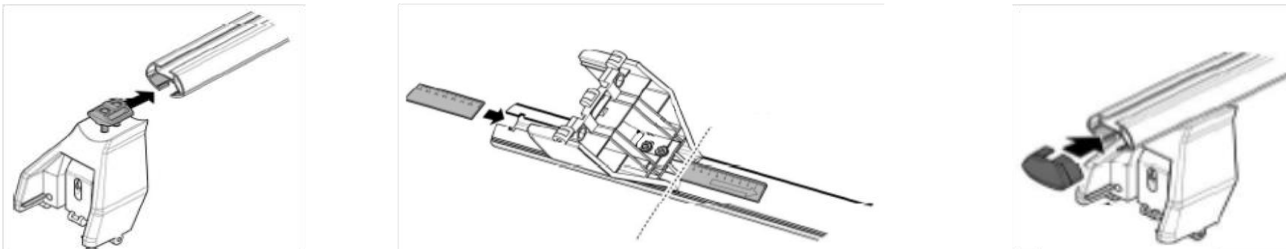

x4

3

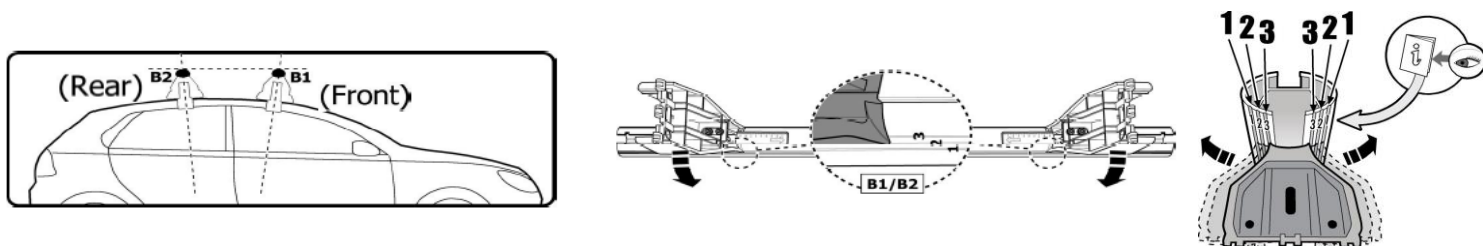

MANUFACTURER	MODEL CAR	DOORS	MODEL YEAR	B1	B2
FIAT	<i>Punto II</i>	3	99>07	1	2
FIAT	<i>Punto II Classic</i>	3	07>10	1	2

4

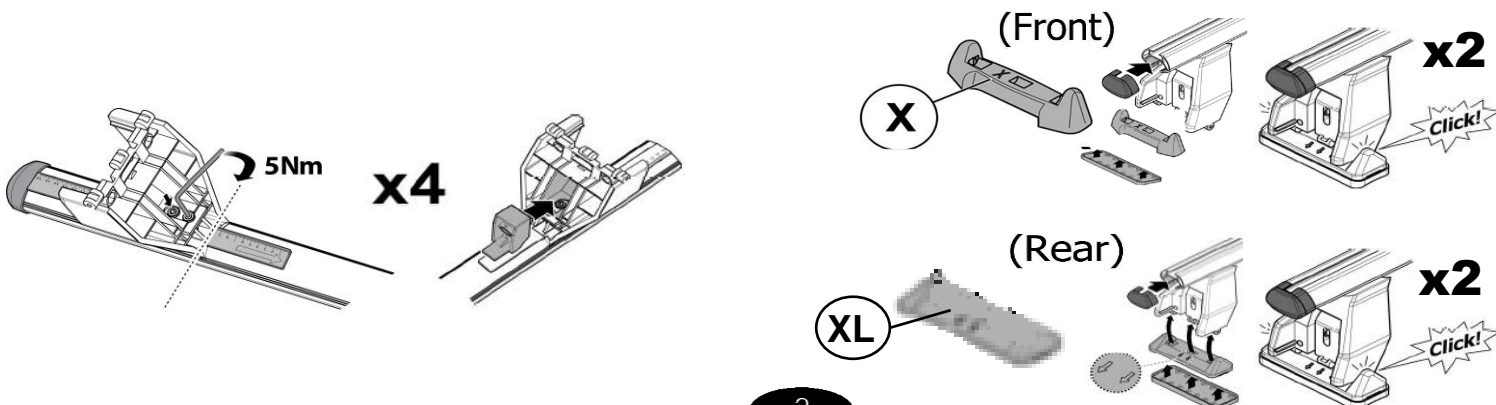

5

(Front)

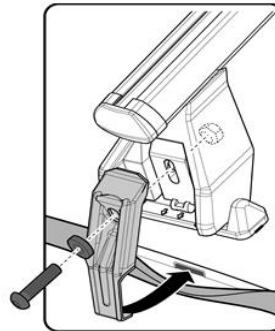
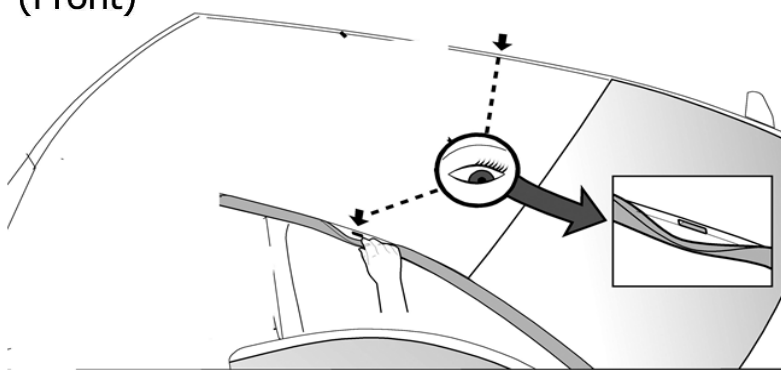

Front
X



9
x2

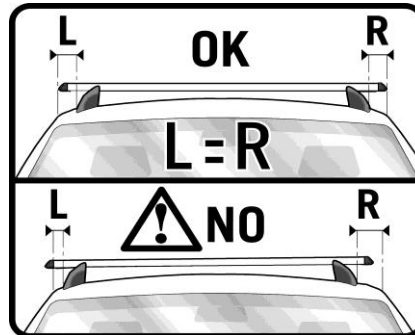
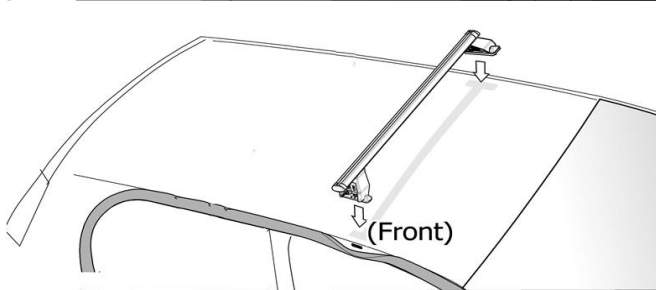

6

(Rear)

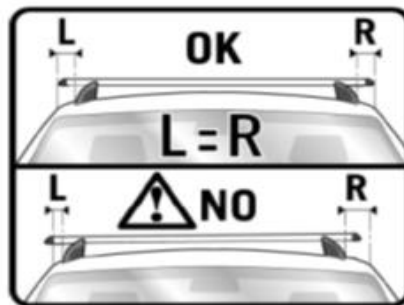
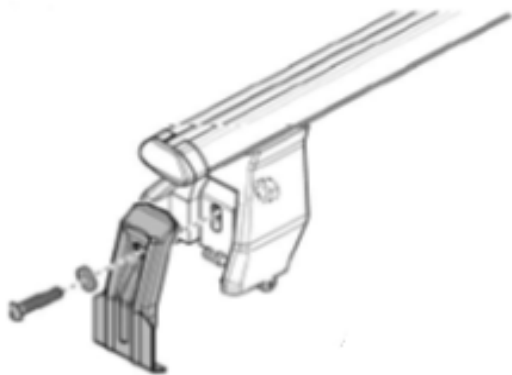

X2

Rear
Y

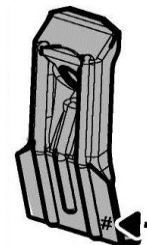

9R
x2

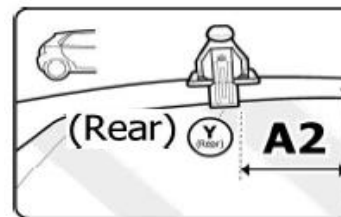
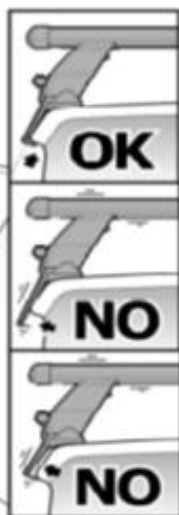
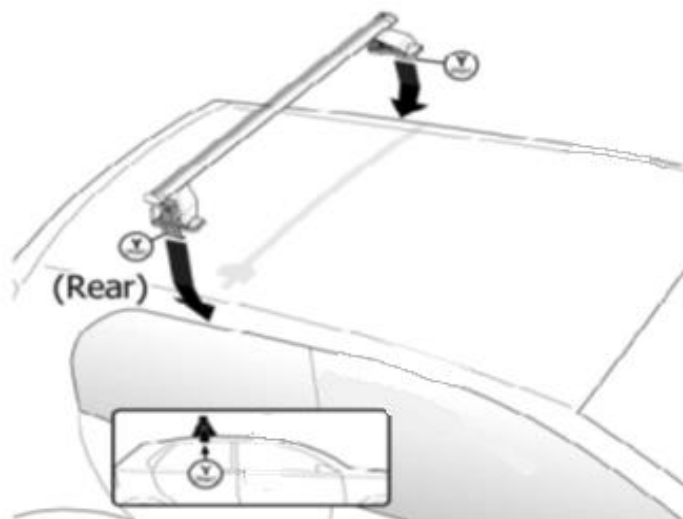

OR

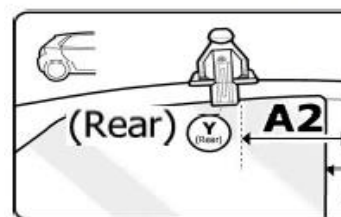

MANUFACTURER	MODEL CAR	DOORS	MODEL YEAR	A1	A2
FIAT	Punto II	3	99>07	X	X
FIAT	Punto II Classic	3	07>10	X	X

X = predisposizione originale /original arrangement